

FLUKE®

Fluke 43B

Power Quality Analyzer

Users Manual

4822 872 30455

April 2001, rev 2, 12-2008

© 2001-2005-2008 Fluke Corporation, All rights reserved. Printed in The Netherlands.
All product names are trademarks of their respective companies.

PLACING ORDERS AND GETTING ASSISTANCE

To locate an authorized service center,
visit us on the World Wide Web:

<http://www.fluke.com>

or call Fluke using any of the phone numbers listed below:

+1-888-993-5853 in U.S.A. and Canada

+31-40-2675200 in Europe

+1-425-446-5500 from other countries

Table of Contents

Chapter	Title	Page
	Unpacking.....	0-1
	Safety Information: Read First	0-2
	Current Probe.....	0-4
1	Introducing the Fluke 43B.....	1-5
	Powering the Fluke 43B.....	1-5
	Inputs.....	1-7
	Main Menu.....	1-8
	Instrument Setup	1-14
	Setting the Date.....	1-14
	Setting the Time.....	1-15
	Adjusting the Contrast.....	1-16
	Selecting Probes.....	1-17
	Setting up the Harmonic- and Power Function.....	1-19
	Selecting a Language.....	1-21
	Using FlukeView Software	1-22
	Using a Printer	1-23
	Selecting a Printer Type.....	1-24
	Resetting the Fluke 43B.....	1-25
2	Maintenance	2-27
	Cleaning and Storage	2-27
	Cleaning the Fluke 43B	2-27
	Storing the Fluke 43B.....	2-27
	Cleaning the Current Probe.....	2-27
	Batteries.....	2-28
	Charging the Batteries.....	2-28
	Extending Battery Operation Time	2-29
	Replacing the Ni-MH Battery Pack.....	2-30
	Ordering Codes.....	2-32
	Replaceable Parts.....	2-32
	Manuals.....	2-33
	Troubleshooting.....	2-34

The Fluke 43B Does Not Start Up.....	2-34
The Screen Remains Black.....	2-34
The Batteries Operate less than Six Hours	2-34
FlukeView Does Not Recognize the Fluke 43B	2-34
The Printer Does Not Print	2-34
3 Specifications	3-35
Introduction.....	3-35
Safety Specifications	3-36
Function Specifications.....	3-37
Electrical functions	3-37
Scope.....	3-39
Meter.....	3-41
Record	3-41
Miscellaneous.....	3-42
Environmental Conditions.....	3-43
Electromagnetic Immunity.....	3-44
Current Probe i-400s	3-45
Safety Specifications.....	3-45
Electromagnetic Compatibility (EMC).....	3-45
Electrical Specifications.....	3-45
General Specifications	3-46
Declaration of Conformity	3-47
LIMITED WARRANTY & LIMITATION OF LIABILITY	3-48

Unpacking

The following items are included in your Fluke 43B kit..

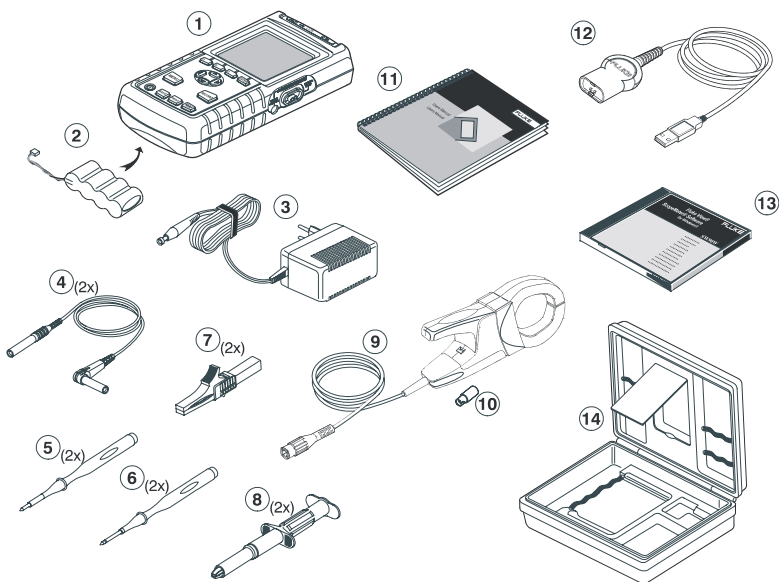

Figure 1. Carrying Case Contents

1	Fluke 43B	Power Quality Analyzer
2	BP120MH	Ni-MH Battery Pack (installed)
3	PM8907/8xx	Power Adapter/Battery Charger
4	TL24	Test Leads, red and black
5	TP1	Flat blade Test Pins, red and black
6	TP4	4mm Test Pins, red and black
7	AC85A	Large Jaw Alligator Clips for Banana Plugs, red and black
8	AC20	Industrial Alligator Clips for Banana Plugs, red and black
9	i400s	Clamp-on AC Current Probe
10	BB120	Shielded Banana-to-BNC Adapter Plugs (1x black)
11		Getting Started Manual incl. User / Application Manual CD
12	OC4USB	Optically Isolated USB Adapter/Cable
13	SW43W	FlukeView [®] Power Quality Analyzer software
14	C120	Hard Carrying Case

Safety Information: Read First



Read the safety information before using the Fluke 43B.

Specific warning and caution statements, where they apply, will be found throughout the manual.

A “Warning” identifies conditions and actions that pose hazard(s) to the user.

A “Caution” identifies conditions and actions that may damage the Fluke 43B.

The following international symbols are used on the Fluke 43B and in this manual:

 Read the safety information in the manual	 Double Insulation (Protection Class)
 Earth	 Equipotential inputs, connected internally
 UL 3111 listed	 UL 1244 listed
 Conformité Européenne	 CSA listed for USA and Canada
 Recycling information	 Disposal information

Warning

To avoid electrical shock, use only a Fluke power supply, Model PM8907 (Power Adapter/Battery Charger).



Warning



Do the following to avoid electrical shock or fire if a Fluke 43B common input  is connected to more than 42 V peak (30 V rms):

- **Use only test leads and test lead adapters supplied with the Fluke 43B (or safety-designed equivalents as specified in the accessory list, see Chapter 2.)**
- **Do not use conventional exposed metal banana plug connectors.**
- **Use only one common connection  to the Fluke 43B.**
- **Remove all test leads that are not in use.**
- **The maximum allowable input voltage is 600V. Use test lead adapters that have a rating of 600V or more.**
- **When powering the Fluke 43B, first connect the power adapter to the outlet before connecting it to the Fluke 43B.**
- **Do not insert metal objects into the power adapter connector of the Fluke 43B.**

Warning

In the scope function it is possible to select AC coupling and to operate time base ranges and amplitude manually. In this case, the measuring results displayed on the screen may not be representative of the total signal. This can result in the presence of dangerous voltages of more than 42 V peak (30 V rms) not being detected. To guarantee user safety, all signals should first be measured with DC coupling. This ensures that the full signal is measured.

The terms 'Isolated' or 'Electrically floating' are used in this manual to indicate a measurement in which the Fluke 43B COM (common, also called ground) is connected to a voltage different from earth ground.

The term "Grounded" is used in this manual to indicate a measurement in which the Fluke 43B COM (common) is connected to an earth ground potential.

The Fluke 43B common inputs (red INPUT 1 shield, gray INPUT 2 shield, and black 4-mm banana COM input) are connected internally via self-recovering fault protection. This is denoted by the ⚡ symbol.

The input connectors have no exposed metal and are fully insulated to protect against electrical shock. The black 4 mm banana jack COM (common) can be connected to a voltage above earth ground for isolated (electrically floating) measurements and is rated up to 600V rms above earth ground.

If Safety-Precautions are Impaired

Using the Fluke 43B in a manner not specified may impair the protection provided by the equipment. Before using, inspect the test leads for mechanical damage and replace damaged test leads!

If it is likely that safety has been impaired, turn the Fluke 43B off and disconnect it from the line power. The matter should then be referred to qualified personnel. Safety is likely to be impaired if, for example, the Fluke 43B fails to perform the intended measurements or shows visible damage.

Current Probe



Warning



- **Use extreme caution when clamping the current probe around uninsulated conductors or bus bars.**
- **Never use the current probe on circuits rated higher than 600V in measurement category III (CAT III) of EN/IEC61010-1**
- **Keep your fingers behind the finger guard.**

Do not use a probe that is cracked, damaged, or has a defective cable. Such probes should be made inoperative by taping the clamp shut to prevent operation.

Chapter 1

Introducing the Fluke 43B

Powering the Fluke 43B

To power the Fluke 43B from a standard AC outlet, perform steps 1-3. For battery power, see Chapter 2.

- 1 Plug the power adapter into the AC outlet.
- 2 Connect the power adapter cable to the Fluke 43B (see Figure 2).

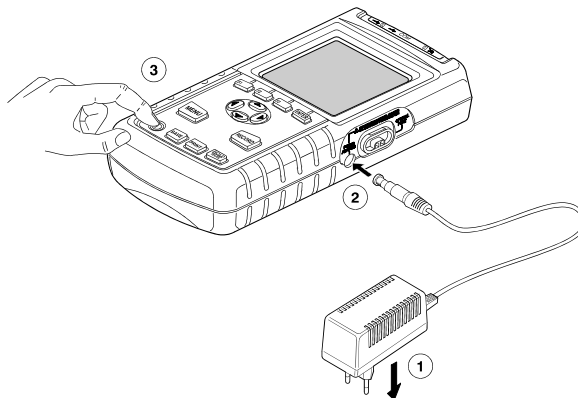



Figure 2. Powering the Fluke 43B

- 3  Turn the Fluke 43B on.

The opening screen will appear on the display (see Figure 3).

Note

If the Fluke 43B does not turn on, the batteries may be dead. Leave the Fluke 43B connected to the outlet for 15 minutes and try again.

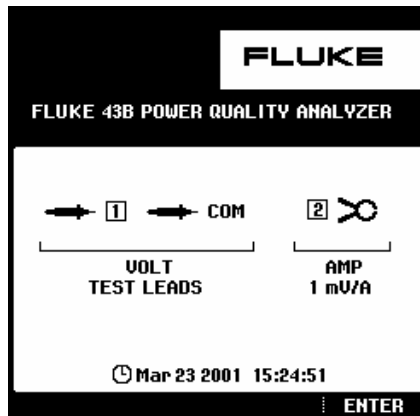

Figure 3. Opening Screen

The screen shows which test leads or probes you should use on the inputs.

Note that in the screen shown in Figure 3, for example, you should use **TEST LEADS** for voltage measurements and a **1 mV/A** current probe for current measurements.

4  Continue.

Inputs

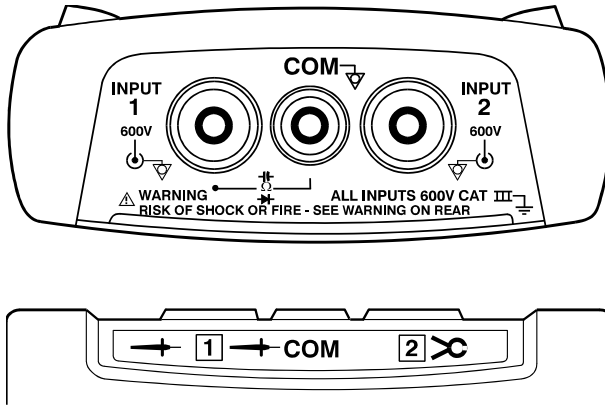





Figure 4. Measurement Connections

INPUT 1: Use the red test lead on input 1 ( **1**).

COM : Use the black test lead on the COM input ( **COM**).

Use these inputs for all voltage measurements, and for Ohm, continuity, diode capacitance and temperature measurements.

The Fluke 43B common inputs  (red INPUT 1 shield, gray INPUT 2 shield, and black COM input) are connected internally via self-recovering fault protection.

INPUT 2: Use the i-400s AC current probe on input 2 ( **2**).



This input is mainly used for current measurements. Use the BB120 banana-to-BNC adapter to connect the current probe.

Note

If you use other test leads or probes, change the probe settings in the instrument setup menu (see "Selecting Probes").

Main Menu

All functions can be easily selected from the main menu.

- 1  Open the main menu.
- 2  **VOLTS/AMPS/HERTZ**
(for example) 

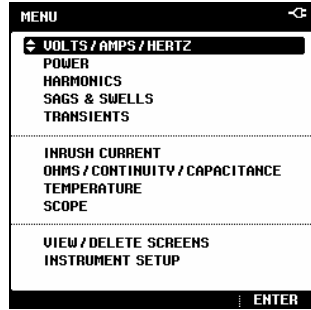

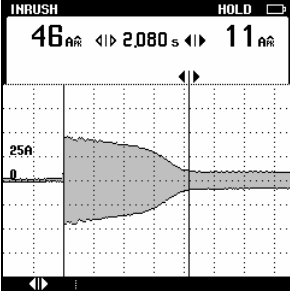
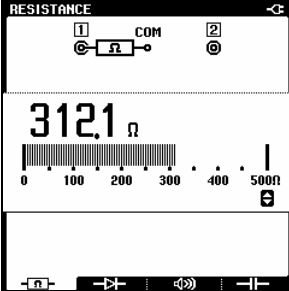
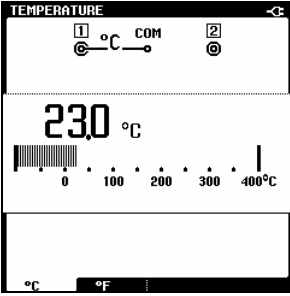
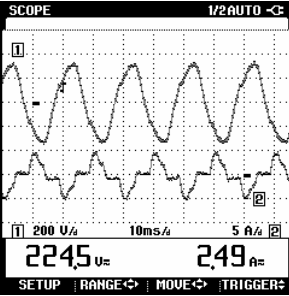
<p>INRUSH CURRENT</p>  <p>Measures inrush current and inrush time (motor start-ups).</p>	<p>OHMS / CONTINUITY / CAPACITANCE</p>  <p>Measures resistance, diodes, continuity and capacitance (DMM).</p>
<p>TEMPERATURE</p>  <p>Measures temperature with optional temperature probe.</p>	<p>SCOPE</p>  <p>Dual channel oscilloscope: Volts on input 1 and Amps on input 2.</p>

VOLTS / AMPS / HERTZ

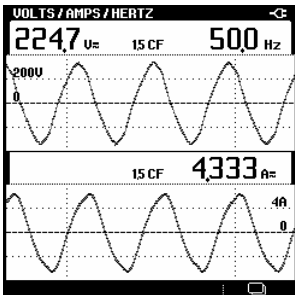

Gives a fast overview of Volts, Amps and Hertz.

POWER

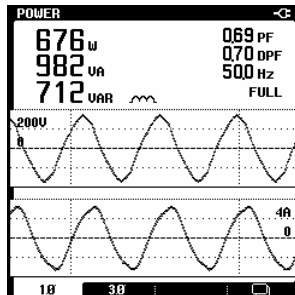

Shows all power readings in one screen.

HARMONICS

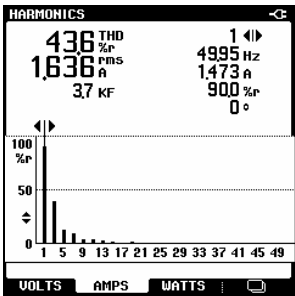

Measures up to 51 harmonics.

SAGS & SWELLS

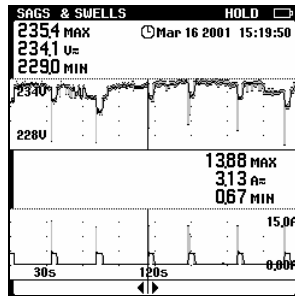

Shows dips and surges as short as one cycle. With time stamp.

TRANSIENTS

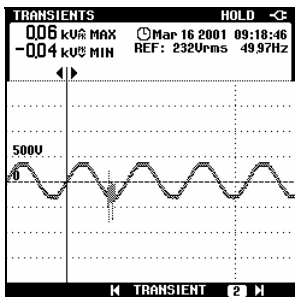

Captures and stores up to 40 voltage transients.

Volts / Amps / Hertz

This function simultaneously shows the voltage and current signal. Also the Crest factor is shown. Use this function to get a first impression of the voltage and current signal before examining the signal in more detail with the other functions.

With the ENTER key you can toggle between Volts / Amps / Hertz, Power, and Harmonics functions.

Power

This function measures and displays the following power readings: active power (W), apparent power (VA), reactive power (VAR), power factor (PF), displacement power factor (DPF or $\cos \phi$) and frequency. The voltage and current waveforms give a visual representation of the phase shifts

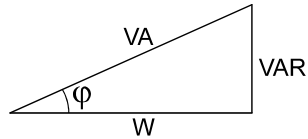

Fluke 43B can perform power measurements on balanced 3-phase, 3-conductor power systems. The load must be well balanced and have either a wye or delta configuration. This makes it possible to measure 3 phase power using single phase connections. The 3 phase power mode measures the fundamental power only.

With the ENTER key you can toggle between Power, Harmonics, and Volts / Amps / Hertz functions.

Harmonics

Harmonics are periodic distortions of the voltage, current, or power sine wave. The signal can be conceived of as a combination of various sine waves with different frequencies. The contribution of each of these components to the full signal is shown as a bar.

The large numbers refer to the full signal; the small numbers belong to the selected harmonic component.

With the ENTER key you can toggle between Harmonics, Volts / Amps / Hertz, and Power functions.

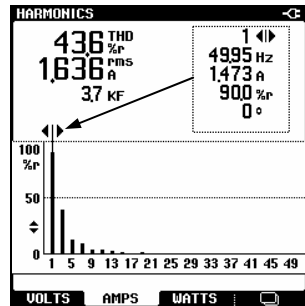

Sags & Swells

Sags and swells measures fast deviations (from one cycle to a few seconds) from the normal voltage signal, and displays current simultaneously.

The results are plotted on the screen as a graph. The graph shows the minimum and maximum values at each point of the graph.

The **SAGS & SWELLS** function is particularly useful to record flicker.

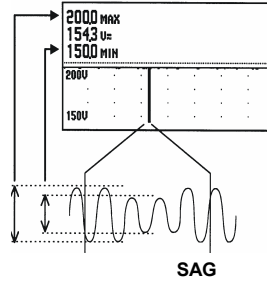

Transients

Transients are fast spikes on the voltage (or current) signal. Spikes may contain enough energy to damage sensitive electronic equipment.

This function detects spikes on the voltage signal and stores a picture of the signal in memory. A transient is detected when it crosses an envelope around the voltage waveform. The width of the envelope can be set manually.

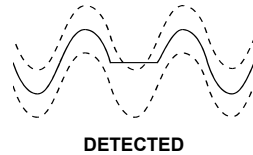
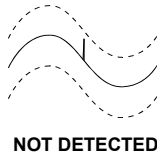
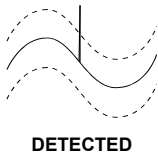

Inrush Current

Inrush currents are surge currents which occur, for example, when a large motor is started.

This function shows the current signal at the moment of the surge. If the current exceeds a specified level, the signal appears as a gray band on the display formed by the peak-peak values of the waveshape.

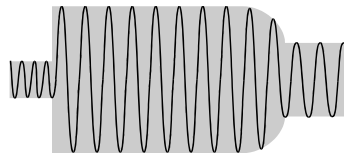

Use **INRUSH CURRENT** to look for inrush currents or other surge currents. Measure the peak current and duration of the surge current.

Time resolution in Sags & Swells and Record modes.

The modes Sags & Swells and Record basically perform similar functions. In both modes Fluke 43B plots a trend of up to two electrical parameters over time. In Sags & Swells mode the instrument plots voltage and current only. In Record mode the analyzer plots a wide variety of parameters, depending on the function that is active when the Record pushbutton is pressed. In both modes the instrument plots the parameters periodically over the so-called plot interval. Refer to the table below for the relationship between Recording Time and Plot Interval. The relationship is based on the fact that there are always 240 plots across the horizontal screen width.

Recording Time	Plot Interval	Recording Time	Plot Interval
4 minutes	1 second	8 hours	2 minutes
8 minutes	2 seconds	16 hours	4 minutes
16 minutes	4 seconds	24 hours	6 minutes
30 minutes	8 seconds	48 hours	12 minutes
1 hour	15 seconds	4 days	24 minutes
2 hours	30 seconds	8 days	48 minutes
4 hours	60 seconds	Endless (16 days)	1 to 96 minutes

Fluke 43B always measures faster than the plot interval: it always is looking at multiple measurements for each point that is plotted. In fact the analyzer looks at all the measurements it has taken during a plot interval and records a minimum, maximum, and average reading. The difference between Sags & Swells and Record mode is in the measuring rate.

Sags & Swells is optimized for measuring short duration variations of current and voltage. The rms current and voltage of every line cycle are measured. The Fluke 43B then records the min (lowest single cycle), max (highest single cycle), and average measurements at the end of each plot interval.

The Record mode takes measurements roughly 250 milliseconds apart. It also records the min, max, and average during each plot interval.

In both Sags & Swells and Record mode the recording time can be set to 'Endless'. This refers to the compression method that is used to generate the plot. With the recording time set to Endless, the plot will start with the 4-minute time scale, and compresses each time the plot runs off the screen. At the end of 4-minutes, the plot will compress to half-screen and the time scale changes to 8 minutes. Fluke 43B does this by looking at every pair of min/max values and keeping only the highest/lowest values. The average values are recalculated. The screen will start with 4 minutes and go to 8 minutes, then 16 minutes, and so on up to 16 days, always keeping the worst-case or extreme values of each plot interval. If you do not know how long you are going to monitor, this will guarantee the best resolution. The process stops after 16 days. The figures below show this process.

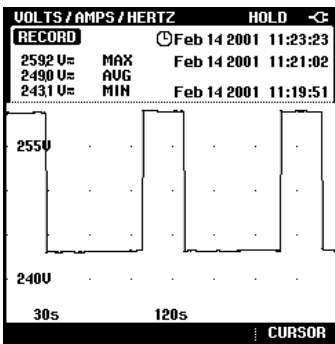

Screen with 4 minutes time scale

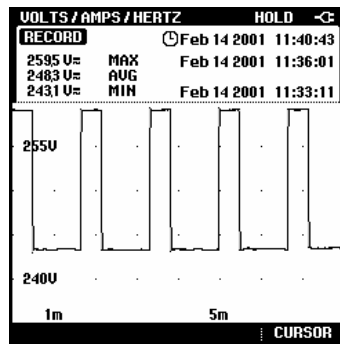

Screen with 8 minutes time scale

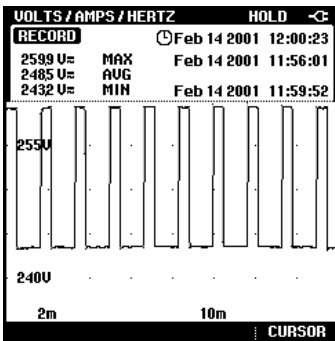





Screen with 16 minutes time scale

Instrument Setup









To change the instrument's default settings and prepare the Fluke 43B for use, follow the instructions in this section.

Begin by selecting the **INSTRUMENT SETUP** screen from the main menu.

- 1  Open the main menu.
- 2   **INSTRUMENT SETUP** 







Setting the Date

- 3   **DATE** 
- 4   **10**  Adjust the month (MM).
- 5   **10** **24**  **1998**

Repeat steps 4 and 5 for day (DD) and year (YY).

- 6   **24**  **MMDDYY** 

Choose the date format.

- 7   **MMDDYY**  (Mar-15-2001)
DDMMYY (15-Mar-2001)
- 8  Accept the new date settings.

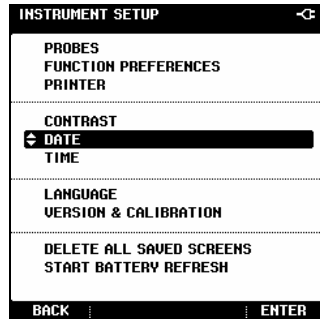

Setting the Time

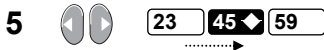
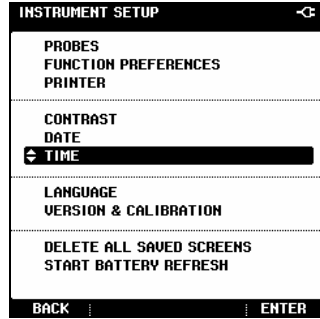



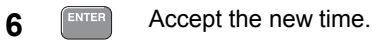







Repeat steps 4 and 5 for minutes and seconds.



Adjusting the Contrast

Adjust the contrast of the screen for optimal visibility of the screen.

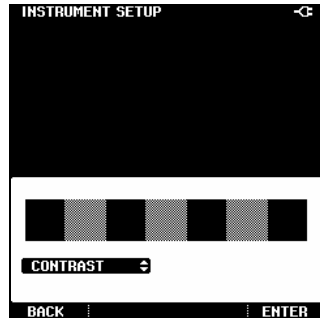
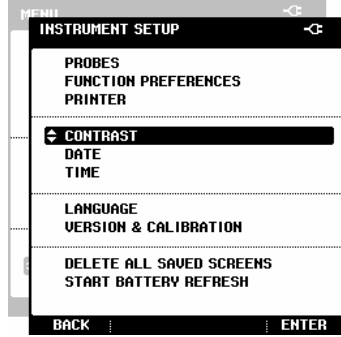

- 1  Open the main menu.
- 2   → 
- 3   → 
- 4   Adjust the contrast until both black and grey squares are clearly visible.
- 5  Accept the new contrast.







Note

You can also adjust the contrast immediately after turning on the Fluke 43B by using the up and down keys.



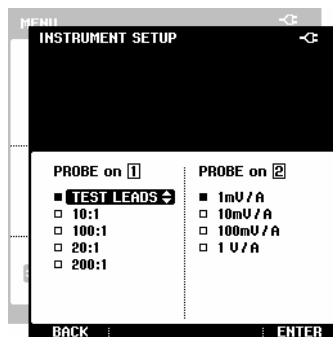

Selecting Probes

For standard operation, use the red test lead on input **1** , the black test lead on COM  and the current clamp on input **2** . If you are using other test leads or probes, you must change the probe settings accordingly.

- 1  Open the main MENU.
- 2  **INSTRUMENT SETUP**
→ 
- 3  **PROBES**
→ 





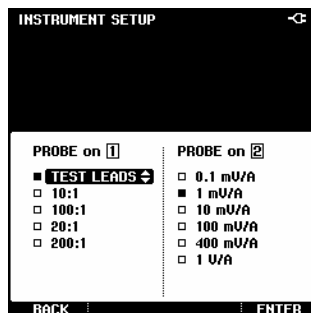

Select the type of probe you are going to use on input 1. For all applications in the Applications Guide, you must use test leads.

- 4  **TEST LEADS** 
(for example)
- 5  Accept the probe settings for input 1. *The screen closes.*
- 6  Select **PROBES** again.



Select the sensitivity of the current probe you are going to use on input 2. For all applications in the Applications Guide, use the i-400s current probe and choose **1 mV/A**.















- 7  Move to the probe settings for input 2.
- 8  
(for the i-400s current probe)
- 9  Accept the probe settings for input 2.

Note

Select 1V/A when using testleads on input [2] in the Scope Mode. A reading of 1A then equals 1V.

Setting up the Harmonic- and Power Function

Before using the Harmonic or Power function, setup the Fluke 43B as follows:

- 1  Open the main MENU.
- 2  **INSTRUMENT SETUP** 
- 3  **FUNCTION PREFERENCES** 
- 4  **%r** (see Table 1)
%f
- 5  Accept the new setting.
The screen closes.
- 6  Select **FUNCTION PREFERENCES** again.
- 7  **DC .. 21**  (see Table 1)
DC .. 33
DC .. 51
- 8  Accept the new setting.
The screen closes.
- 9  Select **FUNCTION PREFERENCES** again.
- 10  **FUNDAMENTAL** (see Table 1)
FULL
- 11  Accept the new settings.

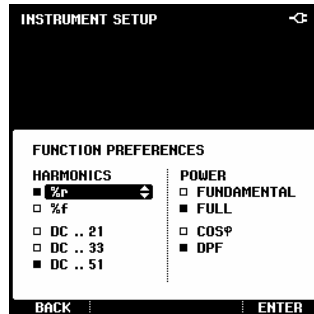
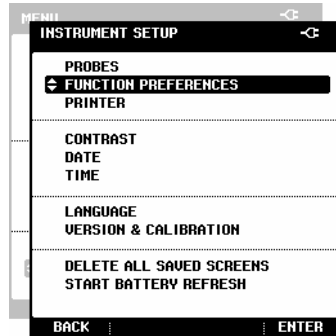

Table 1. Harmonics- and Power Settings











HARMONICS settings	POWER settings
<p>%r Displays harmonics as a percentage of the total harmonic voltages (total Vrms value).</p>	<p>FUNDAMENTAL Uses only the fundamental voltage and fundamental current for power calculations.</p>
<p>%f Displays harmonics as a percentage of the fundamental voltage.</p>	<p>FULL Uses the voltage and current of the full frequency spectrum for power calculations.</p>
<p>DC..21 Displays the DC component DC..33 of the signal and 21, 33 or DC..51 51 harmonics.</p>	<p><i>For signals with harmonics, power readings with FULL selected, will differ from power readings with FUNDAMENTAL selected.</i></p>

Selecting a Language

You can choose between English and other languages. To change the language for example into Spanish, do the following:

Note

Combinations of languages (one or more) depend on the version ordered.

- 1  Open the main MENU.
- 2   
- 3   
- 4   (for example)
- 5  Accept the new language.

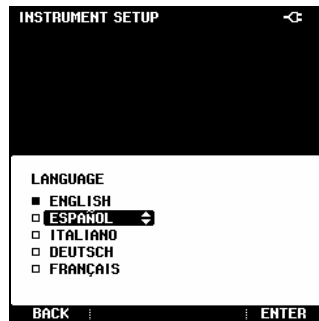
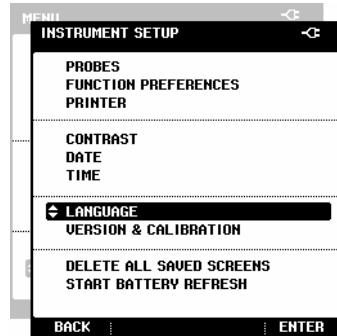

All text on the display immediately changes to the new language.

Using FlukeView Software

This section explains how to connect the Fluke 43B to a PC for use with the FlukeView® Power Quality Analyzer software or to create reports in MS-Word®.

Use the Optically Isolated RS232 Cable on the optical port to connect the Fluke 43B to a PC (see Figure 5).

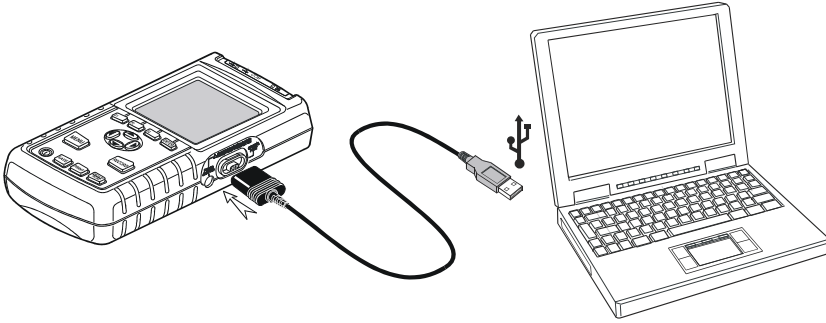

Figure 5. Connecting a Computer

Note

For information about how to install and use the FlukeView software, please read the FlukeView SW43W Users Manual as supplied on CD-ROM.

To create a report in MS-Word, see: “Creating Reports” in Chapter 5 of the Applications Guide.

Using a Printer

This section describes how to connect a printer and how to setup the Fluke 43B for the connected printer.

Connect the Fluke 43B to a parallel printer as shown in Figure 7.

- Use the Print Adapter Cable (PAC91, optional).

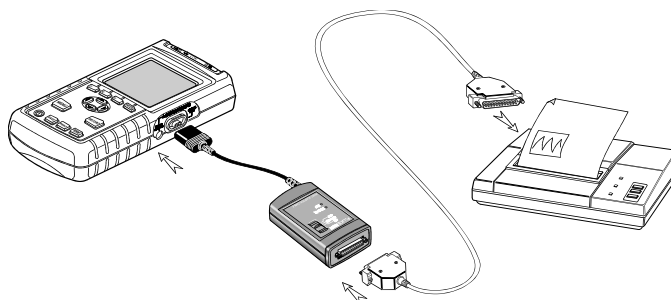









Figure 6. Connecting a Parallel Printer

Note

Some printers are designed for use with Windows only. These printers are not compatible with the Fluke 43B.



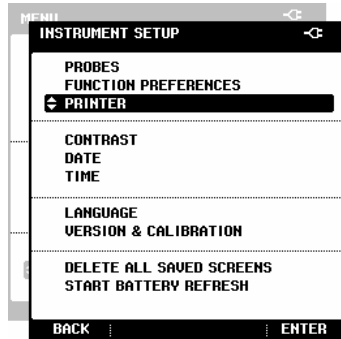

Selecting a Printer Type

Before using a printer, configure the instrument for the type of printer you will be using and its speed.

- 1  Open the main MENU.
- 2   
- 3   





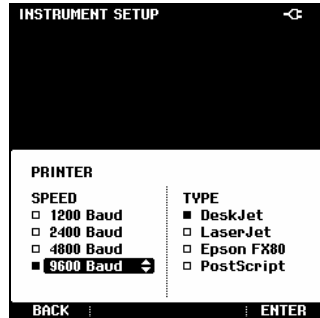

Select the speed of your printer.
Consult the manual that came with your printer to find the optimal baud rate.

- 4   (Required for PAC91)
- 5  Accept the new baud rate.
The screen closes.
- 6  Select **PRINTER** again.



Select the type of printer.

- 7  Move to the right column with printer types.
- 8   (for example)
- 9  Accept the new printer settings.

Now you are ready to print.



- 10  Start printing.

The actual screen will be printed.

Resetting the Fluke 43B

To restore the Fluke 43B to its factory settings and return to the opening screen, reset the Fluke 43B. Resetting does not clear screen memories.

Turn the Fluke 43B off and proceed as follows:

-  Press and hold.
-  Press and release.

The Fluke 43B turns on, and you should hear a double beep, indicating that the reset operation was successful.

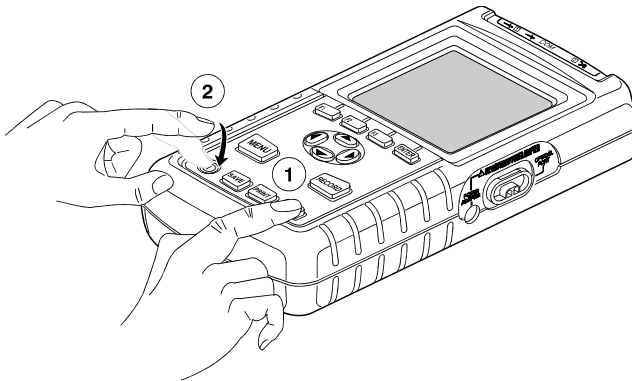

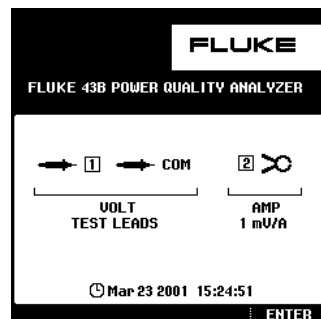

Figure 7. Resetting the Fluke 43B

-  Release the HOLD key.

The opening screen with default settings appears on the display.



-  Continue.

Chapter 2

Maintenance

Cleaning and Storage

Cleaning the Fluke 43B

Clean the Fluke 43B with a damp cloth and a mild soap. Do not use abrasives, solvents or alcohol. These may damage the text on the Fluke 43B.

Storing the Fluke 43B

When storing the Fluke 43B, even for extended periods of time, it is not necessary to remove the battery pack. However, the batteries will gradually discharge. To keep the batteries in optimal condition, charge the batteries periodically (once per month).







Cleaning the Current Probe

Periodically wipe the case with a damp cloth and detergent. Do not use abrasives, solvents or alcohol. Open the jaws and wipe the magnetic pole pieces with a lightly oiled cloth. Do not allow rust or corrosion to form on the magnetic core ends.

Batteries

Charging the Batteries

At delivery, the NI-MH batteries must be charged. When fully charged, the batteries typically provide 6 hours of use.

When the Fluke 43B is powered by the battery, the battery icon at the top of the screen informs you about the condition of the battery. The battery symbols are:     . The symbol  appears when there is less than five minutes of operating time left.

Use the setup as shown in Figure 9 to charge the batteries and power the instrument. To charge the batteries more quickly, turn off the Fluke 43B.

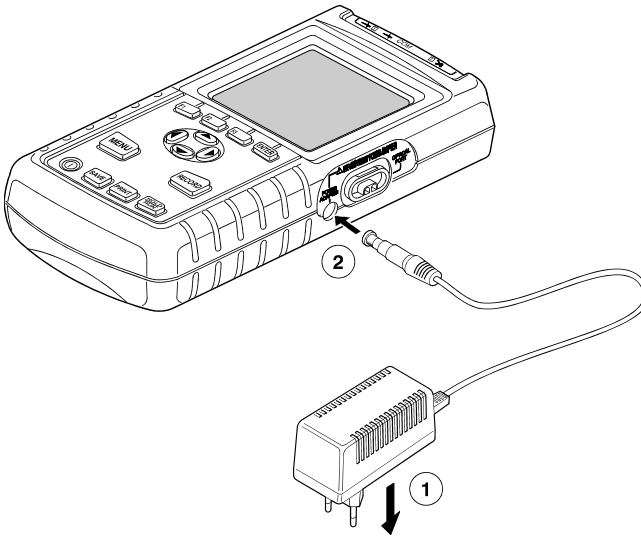



Figure 8. Charging the Batteries







Note

No damage will occur to the instrument if you leave it charging for long periods, e.g. during the weekend.

Extending Battery Operation Time

Charging the batteries when they are not completely empty reduces the battery operating time for the Fluke 43B. To keep the batteries in optimal condition, observe the following guidelines:

- Operate the Fluke 43B on batteries until the  symbol appears at the top of the screen. This indicates that the batteries are very low and that they need to be recharged.
- To extend battery operation time, you can *refresh* the batteries. During a battery refresh, the batteries will be discharged and charged completely. A complete refresh cycle takes about 16 hours and should be done about four times a year.

- 1  Open the main menu.
- 2   **INSTRUMENT SETUP** 
- 3   **START BATTERY REFRESH** 

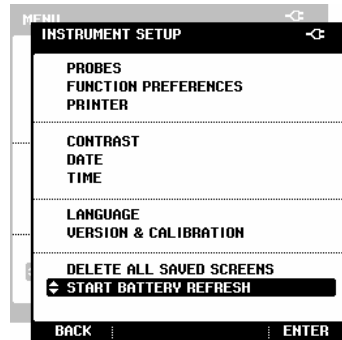

Make sure the Fluke 43B is powered with the power adapter.

- 4  Press YES to continue.

**Do not disconnect the power adapter.
This will interrupt the refresh cycle.**

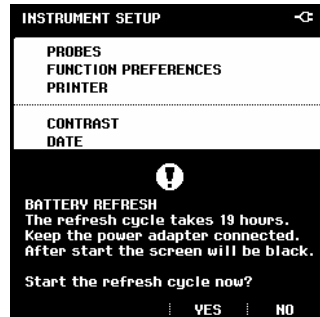

Note

After start of the battery refresh cycle, the screen will be blank. The backlight is on during the refresh cycle.

Replacing the Ni-MH Battery Pack

It should not usually be necessary to replace the battery pack. If you do want to replace the battery pack, follow the instructions below.

Warning

To avoid electrical shock, remove test leads and probes before opening the battery access cover.

- 1** Disconnect test leads and probes both at the source and at the Fluke 43B.
- 2** Locate the battery access cover on the bottom rear. Loosen the screw with a flat-blade screwdriver.
- 3** Remove the battery access cover.
- 4** Take the battery pack out of the compartment.
- 5** Disconnect the battery plug from the connector.
- 6** Install a new battery pack.

Note

Ensure that the battery pack is placed in the battery compartment as shown in Figure 10. Use only the Fluke BP120MH Ni-MH battery pack.

- 7** Reinstall the battery cover and secure the screw.



This instrument contains Ni-MH batteries. Do not dispose of this battery pack with other solid waste. Used batteries should be disposed of by a qualified recycler or hazardous materials handler. Contact your authorized FLUKE Service Center for recycling information.

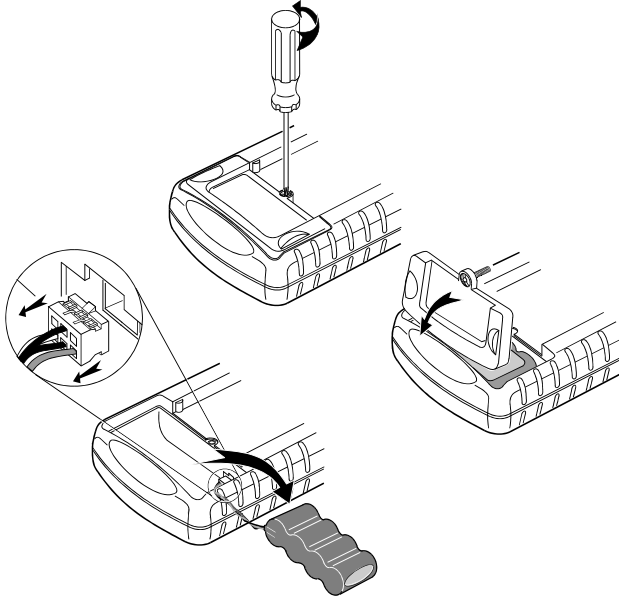











Figure 9. Replacing the Battery Pack

Ordering Codes

The following tables list the user-replaceable parts for the Fluke 43B. For additional *optional* accessories, see the ScopeMeter Accessories booklet. To order replacement parts or additional accessories, contact your nearest service center.

Replaceable Parts

Item		Ordering Code
Ni-MH Battery Pack (installed)		BP120MH
Power Adapter/Battery Charger: Universal Europe 230V, 50Hz North America 120V, 60Hz United Kingdom 240V, 50Hz Japan 100V, 60Hz Australia 240V, 50Hz Universal 115V/230V *	 	PM8907/801 PM8907/813 PM8907/804 PM8907/806 PM8907/807 PM8907/808
* At delivery PM8907/808 is set to 230V. Check the local line voltage before connecting the adapter. If necessary, select the corresponding line voltage with the slide switch on the adapter. A line plug adapter complying with the applicable National Requirements may be provided to alter the blade configurations for a specific country.		
Set of two Test Leads (Red and Black)		TL24
Set of two flat blade Test Pins (Red and Black)		TP1
Set of two 4mm Test Pins (Red and Black)		TP4
Set of two Large Alligator Clips (Red and Black)	 <small>UL 1244</small>	AC85A
Set of two Industrial Alligator Clips (Red and Black)	 <small>UL 1244</small>	AC20
Clamp-on AC Current Probe		i-400s
Shielded Banana-to-BNC Adapter Plug		BB120

Item (Cont'd)	Ordering Code
Optically Isolated RS232 USB Adapter/Cable	OC4USB
FlukeView® Power Quality Analyzer software on CD-ROM	SW43W
Hard Carrying Case	C120

Manuals

Additional manuals can be downloaded from www.fluke.com

FlukeView® User Information	Ordering Code
English, German, French + FlukeView® Power Quality Analyzer software on CD-ROM	2728587

Service Manual	Ordering Code
English	www.fluke.com
Supplement for Service Manual	4822 872 08594

Troubleshooting

The Fluke 43B Does Not Start Up

- The batteries may be dead. Charge the batteries first: power the Fluke 43B with the power adapter without turning it on. After about 15 minutes, try turning on the Fluke 43B again.

The Screen Remains Black

- Make sure that the Fluke 43B is turned on.
- There might be a problem with the contrast. Turn the Fluke 43B off and on again. Now use the up and down keys to adjust the contrast.

The Batteries Operate less than Six Hours

- The battery may be in poor condition. Try refreshing the battery as described in Chapter 2 “*Extending Battery Operation Time*”.

FlukeView Does Not Recognize the Fluke 43B

- Make sure that the Fluke 43B is turned on.
- Make sure that the interface cable is properly connected between the Fluke 43B and the PC.

The Printer Does Not Print

- Make sure that the interface cable is properly connected between the Fluke 43B and the printer.
- Make sure that you have selected the correct printer type (see Chapter 1: “*Selecting a Printer Type*”).
- Make sure that the baud rate you have selected, matches with the baud rate of the printer. If not, select another baud rate (see Chapter 1: “*Selecting a Printer Type*”).
- If you are using the PAC91, make sure that it is turned on.

Chapter 3

Specifications

Introduction

Safety Characteristics

The Fluke 43B has been designed and tested in accordance with the following standards: ANSI/ISA 82.02-01, IEC/EN61010-1-2001, CAN/CSA C22.2 No 61010-1-04 (including cCSAus approval), UL std No 61010-1, Safety Requirements for Electrical Equipment for Measurement, Control and Laboratory Use, Part 1: General requirements.

This manual contains information and warnings that must be followed by the user to ensure safe operation and to keep the instrument in a safe condition. Use of this equipment in a manner not specified by the manufacturer may impair protection provided by the equipment.

Performance Characteristics

FLUKE guarantees the properties expressed in numerical values with the stated tolerance. Specified non-tolerance numerical values indicate those that could be nominally expected from the mean of a range of identical ScopeMeter test tools.

Environmental Data

The environmental data mentioned in this manual are based on the results of the manufacturer's verification procedures.

Safety Specifications

Safety Characteristics

Designed and tested for measurements on 600 V rms Measurement Category III, Pollution Degree 2 in accordance with:

- EN/IEC 61010-1:2001
- ANSI/ISA S82.02-01
- CAN/CSA-C22.2 No.61010.1-04 (including cCSAus approval),
- UL std No 61010-1

Measurement Category III refers to distribution level and fixed installation circuits inside a building.

Maximum input voltage Input 1 and 2

Direct on inputs or with test leads TL24 (see Figure 10)

0 to 66 kHz 600 V rms
> 66 kHz derating to 5 V rms

With Shielded Banana-to-BNC Adapter Plug BB120 (see Figure 10)

0 to 400 kHz 300 V rms
> 400 kHz derating to 5 V rms

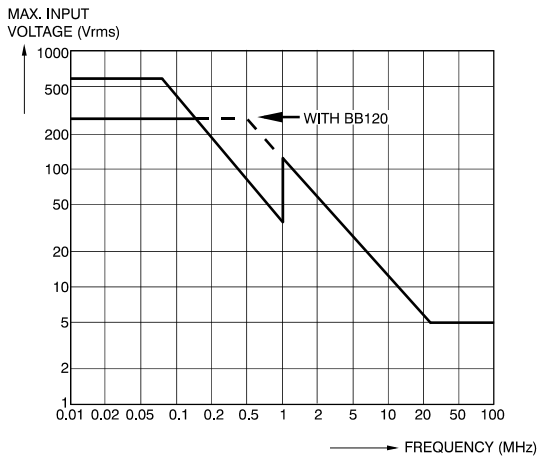

Figure 10. Max. Input Voltage v.s. Frequency

Maximum floating voltage

From any terminal to ground

0 to 400 Hz 600 V rms

Function Specifications

For all specifications, probe specifications must be added.

Electrical functions

Specifications are valid for signals with a fundamental between 40 and 70 Hz.

Minimum input voltage 4 V peak-peak

Minimum input current..... 10 A peak-peak (1 mV/A)

Input bandwidth..... DC to 15 kHz (unless specified otherwise)

Volts / Amps / Hertz

Readings V rms (AC+DC), A rms (AC+DC), Hz

Voltage ranges (auto)..... 5.000 V to 500.0 V, 1250 V
 $\pm(1\% + 10 \text{ counts})$

Current ranges (auto)..... 50.00 A to 500.0 kA, 1250 kA
 $\pm(1\% + 10 \text{ counts})$

Frequency range 10.0 Hz to 15.0 kHz
 40.0 to 70.0 Hz $\pm(0.5\% + 2 \text{ counts})$

CF Crest Factor range 1.0 to 10.0 $\pm(5\% + 1 \text{ counts})$

Power

(1 and 3 Phase, 3 Conductor balanced loads)

Readings Watt, VA, VAR, PF, DPF, Hz

Watt, VA, VAR ranges (auto)..... 250 W to 250 MW, 625 MW, 1.56 GW
 when selected: total (%r): $\pm(2\% + 6 \text{ counts})$
 when selected: fundamental (%f): $\pm(4\% + 4 \text{ counts})$

DPF 0.00 to 1.00
 0.00 to 0.25..... not specified
 0.25 to 0.90..... ± 0.04
 0.90 to 1.00..... ± 0.03

PF 0.00 to 1.00, ± 0.04

Frequency range 10.0 Hz to 15.0 kHz
 40.0 to 70.0 Hz $\pm(0.5\% + 2 \text{ counts})$

Harmonics

Number of harmonics DC..21, DC..33, DC..51

Readings / Cursor readings

V rms / I rms fund. $\pm(3\% + 2 \text{ counts})$
 $31^{\text{st}} \pm(5\% + 3 \text{ counts}), 51^{\text{st}} \pm(15\% + 5 \text{ counts})$

Watt fund. $\pm(5\% + 10 \text{ counts})$
 $31^{\text{st}} \pm(10\% + 10 \text{ counts}), 51^{\text{st}} \pm(30\% + 5 \text{ counts})$

Frequency of fundamental $\pm 0.25 \text{ Hz}$

Harmonics (continued)

Phase fund. $\pm 3^\circ$... 51st $\pm 15^\circ$
K-factor (in Amp and Watt) $\pm 10\%$

Sags & Swells

Recording times (selectable) 4 minutes to 8 days, endless (16 days)

Readings

V rms actual, A rms actual (cycle by cycle calculation) $\pm(2\% + 10 \text{ counts})$
V rms max, A rms max $\pm(2\% + 10 \text{ counts})$
V rms min, A rms min $\pm(2\% + 10 \text{ counts})$

Cursor Readings

V rms max, A rms max $\pm(2\% + 12 \text{ counts})$
V rms average, A rms average $\pm(2\% + 10 \text{ counts})$
V rms min, A rms min $\pm(2\% + 12 \text{ counts})$

Transients

Detection of voltage transients $> 40 \text{ ns}$

Useful bandwidth input 1 (with test leads TL24) DC to 1 MHz

Reference signal V rms, Hz

After START, the V rms and frequency of the signal are measured.

From these data a pure sinewave is calculated.

Detection when transients exceed specified voltage level (selectable)

Voltage levels 20 %, 50 %, 100 %, 200 % of reference signal

Number of transient memories (temporary) 40

Cursor reading

V_{peak} min, V_{peak} max at cursor $\pm 5\%$ of full scale

Inrush Current

Graphic display

Current ranges (selectable) 1 A, 5 A, 10 A, 50 A, 100 A, 500 A, 1000 A

Inrush times (selectable) 1 s, 5 s, 10 s, 50 s, 100 s, 5 min

Cursor readings

A peak max at cursor 1 $\pm 5\%$ of full scale

A peak max at cursor 2 $\pm 5\%$ of full scale

Time between cursors $\pm(0.2\% + 2 \text{ pixels})$

Scope

Input Impedance

Input 1 1 MΩ // 12 pF (± 2 pF). With BB120: 20 pF ± 3 pF
 Input 2 1 MΩ // 10 pF (± 2 pF). With BB120: 18 pF ± 3 pF

Horizontal

Time base modes (selectable) Normal, Single, Roll

Ranges (selectable within modes)

In Normal..... 5 s to 20 ns/div
 In Single shot..... 5 s to 1 μs/div
 In Roll mode 60 s to 1 s/div

Time base error < ±(0.4 % + 1 pixel)

Maximum sampling rate

10 ms to 60 s..... 5 MS/s
 20 ns to 10 ms..... 25 MS/s

Trigger source (AUTO, 1/2 AUTO, MANUAL)..... Input 1 or Input 2

Vertical

Voltage ranges 5.0 mV/div to 500 V/div

Trace accuracy ±(1 % + 2 pixels)

Bandwidth input 1 (voltage)

excluding test leads or probes DC to 20 MHz (-3 dB)
 with test leads TL24..... DC to 1 MHz (-3 dB)
 with 10:1 probe VPS100-R (optional) DC to 20 MHz (-3 dB)
 with shielded test leads STL120 (optional) DC to 12.5 MHz (-3 dB)
 DC to 20 MHz (-6 dB)

Lower transition point (AC coupling)..... 10 Hz (-3 dB)

Bandwidth input 2 (current)

with Banana-to-BNC adapter..... DC to 15 kHz
 Lower transition point (AC coupling)..... 10 Hz (-3 dB)

Scope readings

The accuracy of all scope readings is valid from 18 °C to 28 °C with relative humidity up to 90 % for a period of one year after calibration. Add 0.1 x (the specified accuracy) for each °C below 18 °C or above 28 °C. More than one waveform period must be visible on the screen.

V DC, A DC $\pm(0.5 \% + 5 \text{ counts})$

V AC and V AC+DC (True RMS) input 1

DC to 60 Hz $\pm(1 \% + 10 \text{ counts})$

60 Hz to 20 kHz $\pm(2.5 \% + 15 \text{ counts})$

20 kHz to 1 MHz $\pm(5 \% + 20 \text{ counts})$

1 MHz to 5 MHz $\pm(10 \% + 25 \text{ counts})$

5 MHz to 20 MHz $\pm(30 \% + 25 \text{ counts})$

A AC and A AC+DC (True RMS) input 2

DC to 60 Hz $\pm(1 \% + 10 \text{ counts})$

60 Hz to 15 kHz $\pm(30 \% + 25 \text{ counts})$

Frequency (Hz), Pulse width, Duty cycle (2.0 % to 98.0 %)

1 Hz to 1 MHz $\pm(0.5 \% + 2 \text{ counts})$

1 MHz to 10 MHz $\pm(1 \% + 2 \text{ counts})$

10 MHz to 30 MHz $\pm(2.5 \% + 2 \text{ counts})$

Phase (Input 1 to Input 2)

1 Hz to 60 Hz $\pm 2^\circ$

60 Hz to 400 Hz $\pm 5^\circ$

Peak voltage

Peak max, Peak min $\pm 5 \% \text{ of full scale}$

Peak-peak $\pm 10 \% \text{ of full scale}$

Crest

Range 1.0 to 10.0

$\pm(5 \% + 1 \text{ counts})$

Meter

Ohm

Ranges 500.0Ω to 5.000 MΩ, 30.00 MΩ
±(0.6 % + 5 counts)
 Max. Measurement Current 0.5 mA
 Measurement Voltage at open circuit < 4V

Diode

Accuracy ±(2 % +5 counts)
 Max. Measurement Current 0.5 mA
 Measurement Voltage at open circuit < 4 V

Continuity

Beep < 30 Ω (± 5 Ω)
 Measurement Current 0.5 mA
 Detection of shorts > 1 ms

Capacitance

Ranges 50.00 nF to 500.0 μF
±(2 % +10 counts)
 Max. Measurement Current 0.5 mA

Temperature

Ranges (°C or °F) -100.0 to +400.0 °C or -200.0 to +800.0 °F
±(0.5 % + 5 counts)

Record

Record times (selectable) 4 min to 8 days, endless (16 days)
 Number of readings 1 or 2 simultaneously
 Cursor Readings Accuracy Reading Accuracy ±(2 pixels)

Record is available for the functions:

- volts / amps / hertz
- power
- harmonics
- ohms / continuity / capacitance
- temperature
- scope

Miscellaneous

Display

Useful screen area	72 x 72 mm (2.83 x 2.83 in)
Resolution	240 x 240 pixels
Backlight.....	Cold Cathode Fluorescent (CCFL)

Power

External

Power Adapter.....	PM8907
Input Voltage	10 to 21V DC
Power	5 W typical

Internal

Rechargeable Ni-MH battery pack.....	BP120MH
Voltage range	4 to 6 V DC
Operating Time.....	6 hours
Charging Time.....	7 hours with Fluke 43B off 60 hours with Fluke 43B on
Refresh cycle.....	12 to 19 hours

Memory

Number of screen memories	20
Number of transient memories (temporary).....	40

Mechanical

Height x width x depth	232 x 115 x 50 mm (9.1 x 4.5 x 2 in)
Weight (including battery pack)	1.1 kg (2.5 lbs)

Interface Optically isolated
Supported Printers HP Deskjet®, Laserjet®, PostScript and Epson FX80.
Using HP PCL Protocol, Postscript, and Epson ESC/P Protocol.

Parallel via PAC91 (optically isolated Print Adapter Cable, optional).

Serial via PM9080 (optically isolated RS232 Adapter/Cable, optional).

To PC..... Dump and load settings and data

Via the OCUSB (optically isolated USB Adapter/Cable), or via the PM9080
(optically isolated RS232 Adapter/Cable, optional) using SW43W (FlukeView®
Power Quality Analyzer software)

Environmental Conditions

Environmental MIL-PRF 28800F, Class II

Temperature

During operation 0 to 50 °C (32 to 122 °F)

While stored -20 to 60 °C (-4 to 140 °F)

Humidity

During operation:

0 to 10 °C (32 to 50 °F)..... non-condensing

10 to 30 °C (50 to 86 °F)..... 95 % ± 5 %

30 to 40 °C (86 to 104 °F)..... 75 % ± 5 %

40 to 50 °C (104 to 122 °F)..... 45 % ± 5 %

While stored:

-20 to 60 °C (-4 to 140 °F) non-condensing

Altitude

During operation 4.5 km (15 000 feet)

The maximum input and floating voltage is 600 V rms up to 2 km.

Linearly derating from 600 down to 400 V rms between 2 km to 4.5 km.

While stored 12 km (40 000 feet)

Vibration max. 3g

Shock max. 30g

Electromagnetic Compatibility (EMC)

Emission and Immunity IEC/EN-61326-1:2006

(See also Tables 1 to 3)

Enclosure Protection IP51, ref: IEC/EN-60529

Electromagnetic Immunity

The Fluke 43B, including standard accessories, conforms to the EEC directive 2004/108/EC for EMC immunity as defined by EN-61326-1:2006, with the addition of the following tables.

Disturbance with STL120 and i400s

- Volts / amps / hertz
- Resistance, Capacitance
- Power
- Harmonics

Table 1

No visible disturbance	E = 1 V/m	E = 3 V/m	E = 10 V/m
80 MHz - 1 GHz			5 mV - 500 V/div
1.4 GHz to 2.0 GHz		5 mV - 500 V/div	n.a
2.0 GHz to 2.7 GHz	5 mV - 500 V/div	n.a	n.a

Disturbance with VPS40 and i400s in scope mode

- V AC+DC (True RMS)

Table 2

Disturbance less than 1 % of full scale	E = 1 V/m	E = 3 V/m	E = 10 V/m
80 MHz - 200 MHz		500 mV - 500 V/div	2V - 500 V/div
200 MHz - 1 GHz		(-)	5 mV - 500 V/div
1.4 GHz to 2.0 GHz		(-)	n.a
2.0 GHz to 2.7 GHz	(-)	n.a	n.a

(-): no visible disturbance

Table 3

Disturbance less than 10 % of full scale	E = 1 V/m	E = 3 V/m	E = 10 V/m
80 MHz - 200 MHz		200 mV/div	1 V/div

Ranges not specified in Tables 2 and 3 may have a disturbance of more than 10 % of full scale.

Current Probe i400s

Safety Specifications

Category Rating: CAT III 1000 V and CAT IV 600 V per EN/IEC61010-1, Pollution Degree 2.

: Tested to US and Canadian standards for compliance to UL 61010-1 and CAN/CSA C22.2 No.61010-2-32-04

: EN 61010-2-32:2002

Electromagnetic Compatibility (EMC)

Acc. to EN 61326-1, FCC for emission and immunity

Electrical Specifications

Reference Conditions: 23 ± 5 °C, 20 to 75 % RH; conductor centered in jaw opening; no DC component; no adjacent conductor

	40 A Range	400 A Range
Measurement Range:	0.5 A to 40 A	5 A to 400 A
Output:	10 mV/A	1 mV/A
Accuracy: 45 Hz to 3 kHz	2 % + 0.015 A	2 % + 0.04 A
Phase Shift: (45 Hz to 400 Hz)		
0.5 A to 1 A	Unspecified	NA
1 A to 5 A	4°	NA
5 A to 10 A	3°	Unspecified
10 A to 20 A	3°	2°
20 A to 40 A	2°	2°
40 A to 400 A	NA	1.5°
Crest Factor:	≤3	≤3 to 300 A ≤2.5 to 400 A

Typical Bandwidth: 5 Hz to 10 kHz

Working Voltage: 1000 V ac rms, in compliance with EN61010

Common Mode Voltage: 1000 V ac rms from earth ground, in compliance with EN61010-1

Input Load Impedance (of host instrument): > 1M Ω in parallel with up to 47 pF

Maximum Non-destructive Current: 1000 A

Duty Cycle: 0.5 A to 400 A continuous

Influence of Adjacent Conductor: < 9.0 mA/A

Influence of Conductor Position in Jaw Opening: ± 1.0 % of reading +0.05 A

General Specifications

Output Cable Length: 2.5 m

Maximum Conductor Size: 32 mm

Storage Temperature: -20 °C to 60 °C

Operating Temperature: 0 °C to 50 °C

Relative Humidity:

10 °C to 30 °C:	95 %
30 °C to 40 °C:	75 %
40 °C to 50 °C:	45 %

Temperature Coefficient: 0.01 % x (specified accuracy)/ °C (< 18 °C or > 28 °C)

Altitude: Operating: 2000 m; 2000 m to 4000 m, derate category rating to 1000 V CAT II/600 V CAT III, Non-operating: 12000 m

Dimensions: 150 x 70 x 30 mm

Weight: 114 g

Declaration of Conformity

for

Fluke 43B Power Quality Analyzer

Manufacturer

Fluke Industrial B.V.
Lelyweg 14
7602 EA Almelo
The Netherlands

Statement of Conformity

Based on test results using appropriate standards,
the product is in conformity with
Electromagnetic Compatibility Directive 2004/108/EC
Low Voltage Directive 2006/95/EC

Sample tests

Standards used:

EN 61010-1-2001
Safety Requirements for Electrical Equipment for Measurement, Control,
and Laboratory Use

EN 61326-1-2006
Electrical equipment for Measurement Control and Laboratory use
EMC requirements

The tests have been performed in a typical configuration.

This Conformity is indicated by the symbol **CE**,
i.e. "Conformité européenne".

LIMITED WARRANTY & LIMITATION OF LIABILITY

Each Fluke product is warranted to be free from defects in material and workmanship under normal use and service. The warranty period is three years for the Test Tool and one year for its accessories. The warranty period begins on the date of shipment. Parts, product repairs and services are warranted for 90 days. This warranty extends only to the original buyer or end-user customer of a Fluke authorized reseller, and does not apply to fuses, disposable batteries or to any product which, in Fluke's opinion, has been misused, altered, neglected or damaged by accident or abnormal conditions of operation or handling. Fluke warrants that software will operate substantially in accordance with its functional specifications for 90 days and that it has been properly recorded on non-defective media. Fluke does not warrant that software will be error free or operate without interruption.

Fluke authorized resellers shall extend this warranty on new and unused products to end-user customers only but have no authority to extend a greater or different warranty on behalf of Fluke. Warranty support is available if product is purchased through a Fluke authorized sales outlet or Buyer has paid the applicable international price. Fluke reserves the right to invoice Buyer for importation costs of repair/replacement parts when product purchased in one country is submitted for repair in another country.

Fluke's warranty obligation is limited, at Fluke's option, to refund of the purchase price, free of charge repair, or replacement of a defective product which is returned to a Fluke authorized service center within the warranty period.

To obtain warranty service, contact your nearest Fluke authorized service center or send the product, with a description of the difficulty, postage and insurance prepaid (FOB Destination), to the nearest Fluke authorized service center. Fluke assumes no risk for damage in transit. Following warranty repair, the product will be returned to Buyer, transportation prepaid (FOB Destination). If Fluke determines that the failure was caused by misuse, alteration, accident or abnormal condition of operation or handling, Fluke will provide an estimate of repair costs and obtain authorization before commencing the work. Following repair, the product will be returned to the Buyer transportation prepaid and the Buyer will be billed for the repair and return transportation charges (FOB Shipping Point).

THIS WARRANTY IS BUYER'S SOLE AND EXCLUSIVE REMEDY AND IS IN LIEU OF ALL OTHER WARRANTIES, EXPRESS OR IMPLIED, INCLUDING BUT NOT LIMITED TO ANY IMPLIED WARRANTY OF MERCHANTABILITY OR FITNESS FOR A PARTICULAR PURPOSE. FLUKE SHALL NOT BE LIABLE FOR ANY SPECIAL, INDIRECT, INCIDENTAL OR CONSEQUENTIAL DAMAGES OR LOSSES, INCLUDING LOSS OF DATA, WHETHER ARISING FROM BREACH OF WARRANTY OR BASED ON CONTRACT, TORT, RELIANCE OR ANY OTHER THEORY.

Since some countries or states do not allow limitation of the term of an implied warranty, or exclusion or limitation of incidental or consequential damages, the limitations and exclusions of this warranty may not apply to every buyer. If any provision of this Warranty is held invalid or unenforceable by a court of competent jurisdiction, such holding will not affect the validity or enforceability of any other provision.

Fluke Corporation, P.O. Box 9090, Everett, WA 98206-9090 USA, or

Fluke Industrial B.V., P.O. Box 90, 7600 AB, Almelo, The Netherlands

Index

—%—

%f (setting), 20

%r (setting), 20

—A—

Accessories, 1, 32

AUTO, 1/2 AUTO, 39

—B—

Battery

Charging, 28

Extending Operation Time, 29

Operation Time, 42

Replacing, 30

Battery Refresh, 29, 42

Baud Rate, 24

—C—

Case Contents, 1

Category

Current Probe, 46

Fluke 43B, 36

Charging Batteries, 28

Charging Time, 42

Cleaning, 27

Common Inputs, 3, 7

Connecting

Current Probe, 7

Printer, 23

Test Leads, 7

Connecting a Computer, 22

Contrast, 16

—D—

Date, Setting, 14

Default Settings, 25

Diode Function, 8

Dips, measuring, 9

—F—

Flukeview Software, 22

Fundamental (setting), 20

—H—

Harmonics

Function, 9

Setup, 20

Specifications, 37, 38

Harmonics Function, 10

—I—

Initial Settings, 25

Inrush Current Function, 8, 11

Interface Cable RS232, 22, 23

—L—

Language, Setting, 21

—M—

Main Menu, 8

Manuals, 33

Manual, 39

Maximum Floating Voltage, 36

Maximum Input Voltage, 36

Measurement Connections, 7

Memories, 42

Menu Key, 8

—O—

Ohm / Continuity / Capacitance

Function, 8

Opening Screen, 6

Operating Time, 42

Optional Accessories, 32

Ordering Codes, 32, 33

—P—

Parallel Printer, 23

Power

Function, 9, 10

Setup, 20

Specifications, 37

Power Adapter, 5

Powering, 5

Preferences, 19

Print Key, 24

Printer, 23, 24

Printing, 24

Probe Setup, 17

Problems, 34

—R—

Record, 41

Record Key. *See Applications Manual*

Replaceable Parts, 32

Replacing Battery Pack, 30

Resetting, 25

Resolution, 42

RS232 Communication, 22, 23

—S—

Safety Characteristics, 35, 36

Safety Information, 2

Safety Precautions, 2

Sags & Swells Function, 9, 10

Save Key. *See Applications Manual*

Scope Function, 8

Screen Memories, 42

Screen Resolution, 42

Serial Printer, 23

Setting Up

Date, 14

Harmonics Function, 19

Language, 21

Power Function, 19

Printer, 24

Probes, 17

Time, 15

Spikes, Measuring, 9, 11

Storing, 27

Surges, measuring, 9

—T—

Temperature Function, 8

Three Phase, 10, 37

Time, Setting, 15

Time Resolution, 12

Total (setting), 20

Transient Detection, 38

Transient Memories, 38, 42

Transients Function, 9, 11

Troubleshooting, 34

—U—

UL-Listing, 2, 35

Unpacking, 1

—V—

Volts / Amps / Hertz Function, 9